



Vienna Ambient, Heated & Specialty

RPI INDUSTRIES, INC.

PROPERTY



VIENNA SELECT COLD CORNER SERIES



VSCD3-27-R-SQ-SC M

The Vienna select series cold corner unit offers a 90 degree angle, combination refrigerated deck area, with ambient shelves above. Units can be provided in square glass closed display, with open rear section for easy operator access!

MODEL	L	D	H
VSCD3-27-R-SQ-SC M	51"	30 3/4"	51 1/8"

SHOWN WITH OPTIONAL FLEX SERIES PANEL SYSTEM

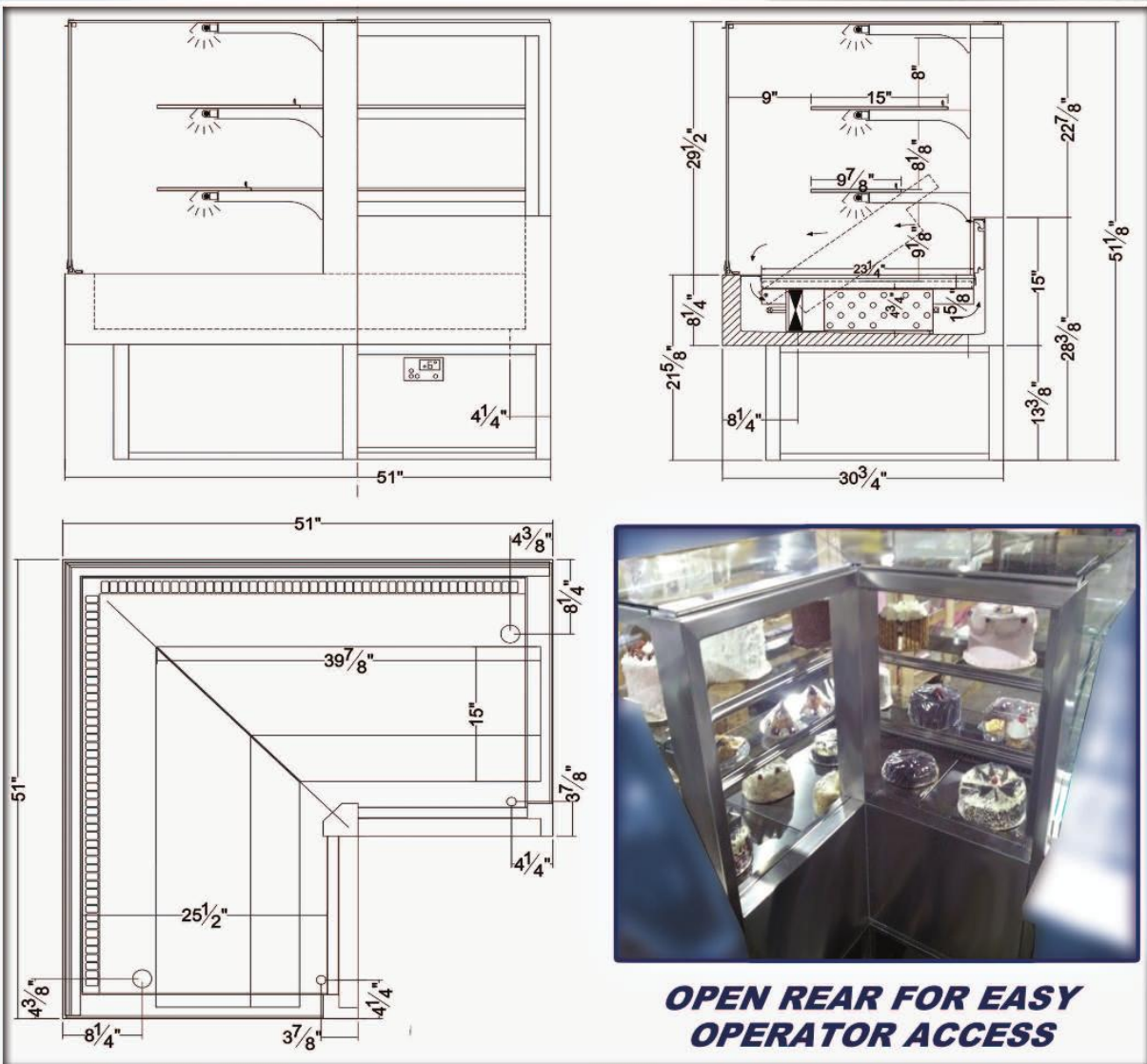

OPEN REAR FOR EASY OPERATOR ACCESS

4.

CONSULT FACTORY FOR ADDITIONAL INFORMATION

VICC2-R-SQ-SC VC

The Vienna Vertical Combo Series is a combination of a cold grab and go bottom display and a cold / ambient display for assisted service on top. The two displays can be operated separately, and different temperature capabilities for top and bottom sections are possible. Each unit features its own condensing unit with rear-breathing. The VICC2-R-SQ-SC VC is entirely made of stainless steel, with printed glass on the left and right side.



SIDE ELEVATION

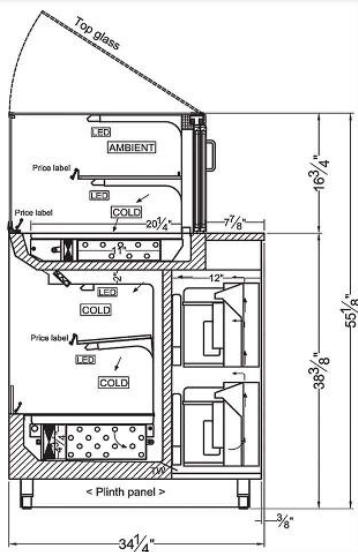

SIZES & SPECIAL FEATURES

MODEL	L	D	H
VICC2-R-SQ-SC VC	35 3/8"	34 1/4"	55 1/8"

FLOOR DRAIN REQUIRED



CONSULT FACTORY FOR ADDITIONAL INFORMATION

VIENNA VERTICAL COMBO SERIES 5.

VIENNA CAFE SERIES

VIAS1-27-R-SQ-SC CAFE VICD3-27-R-SQ-SC CAFE



The Vienna Cafe Series offers a new tempered radius style insulated glass, without adding stainless trim on edging, giving maximum visual appeal to merchandising!

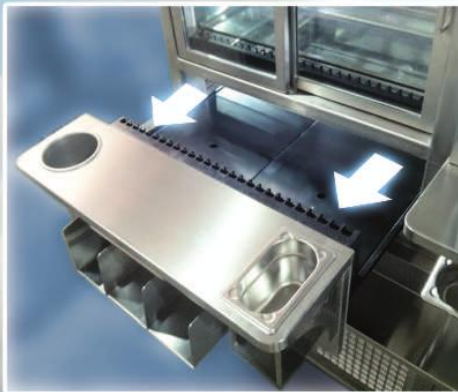

**SLIDE-OUT REFRIGERATED
REAR ACCESS DRAWER**

ADDED FEATURES INCLUDE:

- Slide-out refrigerated rear access drawer for ease of product selection
- Middle Shelf (Refrigerated)
- Top Shelf (Non-Refrigerated)
- Energy Efficient LED Lighting
- Full Height Grab & Go Refrigerated Section with Common Insulated Glass Divider Panel

REAR ELEVATION

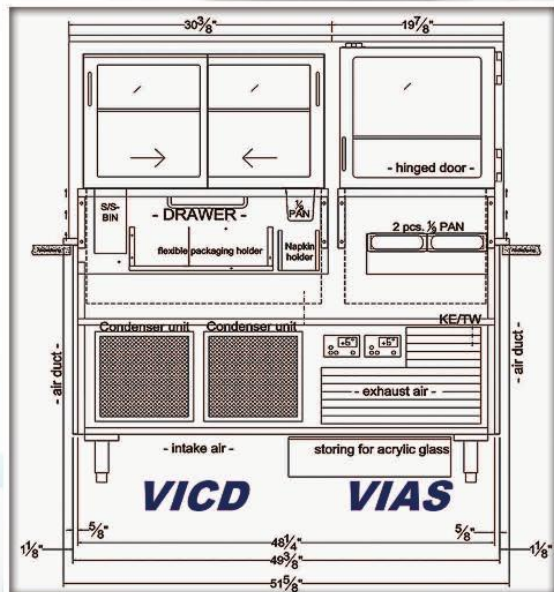

MODEL	L	D	H*
VICD3-27-R-SQ-SC CAFE	30 3/8"	39"	25 1/2"

MODEL	L	D	H*
VIAS1-27-R-SQ-SC CAFE	19 7/8"	39"	25 1/2"

* Represents heights above counter

6. AVAILABLE WITH OPTIONAL FLEX SERIES PANEL SYSTEM

VICD1-34-R-SQ-SC MD

The Vienna Multi Deck Series offers a larger capacity of display with a compact footprint at an incredible value! Full glass front and sides with extended solid end panels enable the unit to easily fit within serving counters!

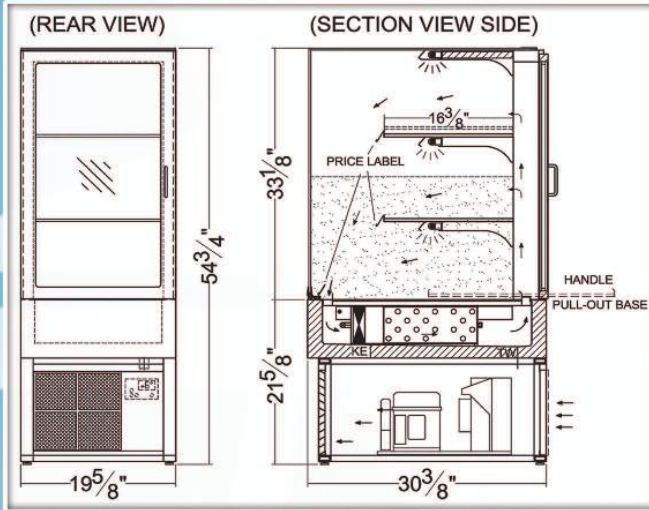

AVAILABLE WITH OPTIONAL FLEX SERIES PANEL SYSTEM

MODEL	L	D	H*
VICD1-34-R-SQ-SC MD	19 5/8"	30 3/8"	54 3/4"

* Represents Overall Height

SPECIAL FEATURES



HINGED REAR ACCESS DOOR

FLEX SERIES PANELING



CONSULT FACTORY FOR ADDITIONAL INFORMATION

VIENNA MULTI-DECK SERIES

7.

VIENNA CHEESE CABINET

VICD2-34-R-SQ-RR-KS (MOD)



The Vienna Series Cheese Cabinet is the perfect solution for a cheese display system to merchandise product for short to medium durations. This unit features oversized drawers with standard wooden slats in the base for additional product storage, and adjustable shelves with wooden slats for 2 cheeses are also available. Refrigeration is designed for separate top zone and bottom zone with independent variable speed fans allowing flexibility within cabinet for temperature and humidity.

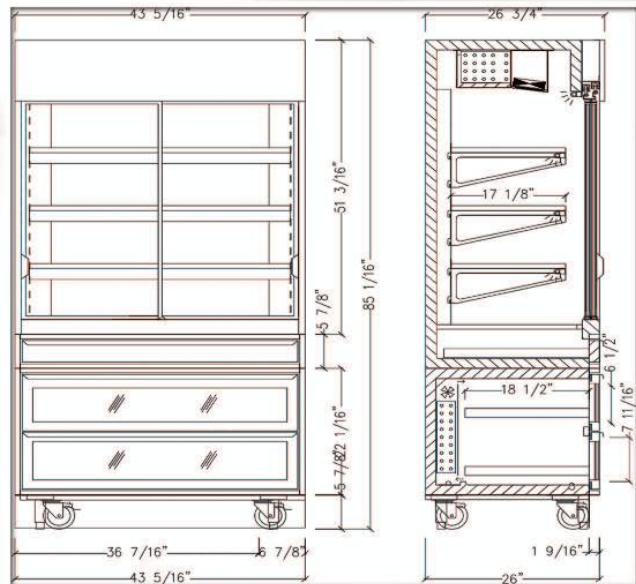

MODEL	L	D	H
VICD2-34-R-SQ-RR-KS (MOD)	43 5/16"	26"	85 1/16"

Special construction

SPECIAL FEATURES



8. Abundant Lower Storage!



Holds Utencils as Well!

VICD2-68-R-RR (M)

The Vienna Wine Cooler Cabinet is designed for optimal storage and presentation of red wine, white wine or sparkling wine. Unit is built with Individual temperature controls per door section, and features 12 slanted supports for 750 ml bottles, and various other sizes.

Hinged front access doors



MODEL	L*	D	H
VICD2-68-R-RR (M)	26 3/8"	26 3/8"	87"

*** Lengths = 52 3/4" Total**

SPECIAL FEATURES

Unique Tilted-Tier Racking System



CONSULT FACTORY FOR ADDITIONAL INFORMATION

VIENNA WINE CABINET

9.

VIENNA GELATO SERIES VIG-CV



VIG-CV CURVED GLASS

The Vienna Series VIG-CV is a refrigerated display merchandiser designed specifically for gelato, featuring state of the art electronic refrigeration system, auto hot gas defrost to protect product from losing it's texture and quality. Includes curved glass profile, glass end panels and top canopy light. Unit has a stainless steel base, a slanted presentation style deck for ultimate display and is designed to accommodate standard hotel / foodservice pans. Can also be used to slide into a counter for a drop-in appearance / application.

FLOOR DRAIN REQUIRED



SIZES & SPECIAL FEATURES



10.

REAR SLIDING ACCESS DOORS



VIG-SQ SQUARED GLASS AVAILABLE

MODEL	L	D	H
VIG-32-R-CV-SC	31 1/2"	28 3/8"	47 1/2"
VIG-48-R-CV-SC	47 1/4"	28 3/8"	47 1/2"
VIG-60-R-CV-SC	63 3/4"	28 3/8"	47 1/2"



VIENNA COUNTER TOP COLD DISPLAY VICD-CV CT



VICD2-20-R-CV-SC CT



VICD3-20-R-CV-SC CT

VICD-CV CT CURVED GLASS

The Vienna Series VICD-CV CT is a refrigerated full service display style unit designed for counter top application, featuring insulated curved front glass, top and side panels. Units are standard in stainless steel with an adjustable shelf, lights and sliding rear see-through access doors.

FLOOR DRAIN REQUIRED



6' CORD & PLUG

SIZES & SPECIAL FEATURES

MODEL	L	D	H
VICD2-20-R-CV-SC CT	31 1/2"	32 5/8"	28 3/8"
VICD3-20-R-CV-SC CT	44 1/4"	32 5/8"	28 3/8"

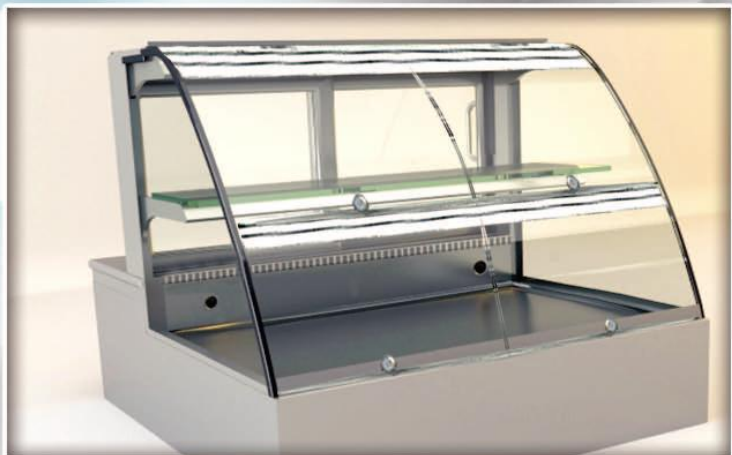

FRONT FLIP-UP ACCESS DOORS

VIENNA COUNTER TOP COLD DISPLAY VICD-SQ CT

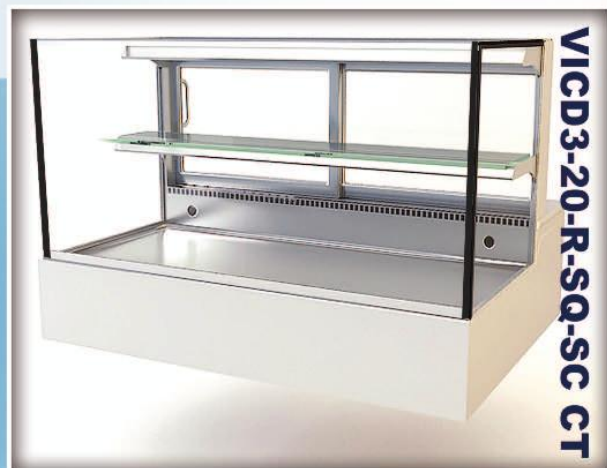

VICD3-20-R-SQ-SC CT



VICD2-20-R-SQ-SC CT

VICD-SQ CT SQUARED GLASS



6' CORD & PLUG

The Vienna Series VICD-SQ CT is a refrigerated full service display style unit designed for counter top application, featuring insulated squared front glass, top and side panels. Units are standard in stainless steel with an adjustable shelf, lights and sliding rear see-through access doors.

FLOOR DRAIN REQUIRED

SIZES & SPECIAL FEATURES

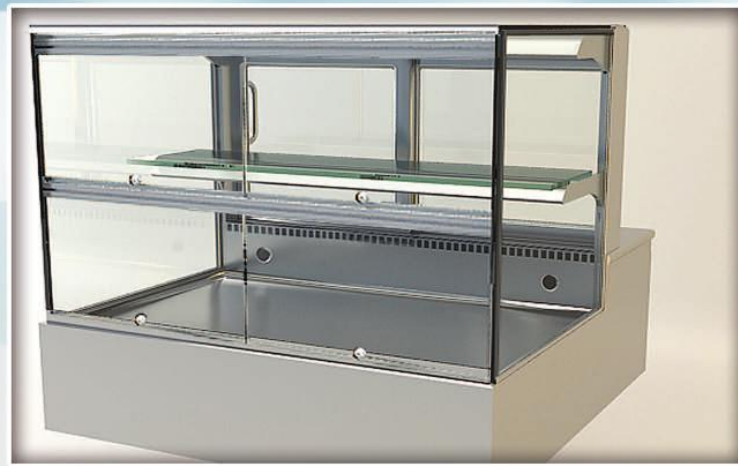

FRONT FLIP-UP ACCESS DOORS

MODEL	L	D	H
VICD2-20-R-SQ-SC CT	31 1/2"	32 5/8"	28 3/8"
VICD3-20-R-SQ-SC CT	44 1/4"	32 5/8"	28 3/8"

VIENNA DRY DISPLAY SERIES VIDD-CV



VIDD-CV CURVED GLASS

The Vienna Series VIDD-CV is a non-refrigerated full service display merchandiser designed for countertop application. Unit features curved tilt-open front glass for ease of cleaning and see through hinged rear doors. Can complete a dual temperature line-up next to our VICD-CV cold display models!

MODEL	L	D	H
VIDD2-20-R-CV	31 1/2"	27 3/8"	20 7/8"
VIDD3-20-R-CV	44 1/4"	27 3/8"	20 7/8"
VIDD4-20-R-CV	57 1/8"	27 3/8"	20 7/8"
VIDD5-20-R-CV	69 7/8"	27 3/8"	20 7/8"
VIDD2-27-R-CV	31 1/2"	27 3/8"	27 1/2"
VIDD3-27-R-CV	44 1/4"	27 3/8"	27 1/2"
VIDD4-27-R-CV	57 1/8"	27 3/8"	27 1/2"
VIDD5-27-R-CV	69 7/8"	27 3/8"	27 1/2"
VIDD2-34-R-CV	31 1/2"	27 3/8"	34 1/4"
VIDD3-34-R-CV	44 1/4"	27 3/8"	34 1/4"
VIDD4-34-R-CV	57 1/8"	27 3/8"	34 1/4"
VIDD5-34-R-CV	69 7/8"	27 3/8"	34 1/4"



ADJUSTABLE SHELVING

SPECIAL FEATURES



OPTIONAL FLIP-UP ACCESS DOORS AVAILABLE!

14.

CONSULT FACTORY FOR ADDITIONAL INFORMATION

VIDD-SL SLANTED GLASS

The Vienna Series VIDD-SSL is a non-refrigerated full service display merchandiser designed for countertop application. Unit features slanted tilt-open front glass for ease of cleaning and see through hinged rear doors. Can complete a dual temperature line-up next to our VICD-SL cold display models!



ADJUSTABLE SHELVING

MODEL	L	D	H
VIDD2-20-R-SL	31 1/2"	27 3/8"	20 7/8"
VIDD3-20-R-SL	44 1/4"	27 3/8"	20 7/8"
VIDD4-20-R-SL	57 1/8"	27 3/8"	20 7/8"
VIDD5-20-R-SL	69 7/8"	27 3/8"	20 7/8"
VIDD2-27-R-SL	31 1/2"	27 3/8"	27 1/2"
VIDD3-27-R-SL	44 1/4"	27 3/8"	27 1/2"
VIDD4-27-R-SL	57 1/8"	27 3/8"	27 1/2"
VIDD5-27-R-SL	69 7/8"	27 3/8"	27 1/2"
VIDD2-34-R-SL	31 1/2"	27 3/8"	34 1/4"
VIDD3-34-R-SL	44 1/4"	27 3/8"	34 1/4"
VIDD4-34-R-SL	57 1/8"	27 3/8"	34 1/4"
VIDD5-34-R-SL	69 7/8"	27 3/8"	34 1/4"

SPECIAL FEATURES

OPTIONAL FLIP-UP ACCESS DOORS AVAILABLE!

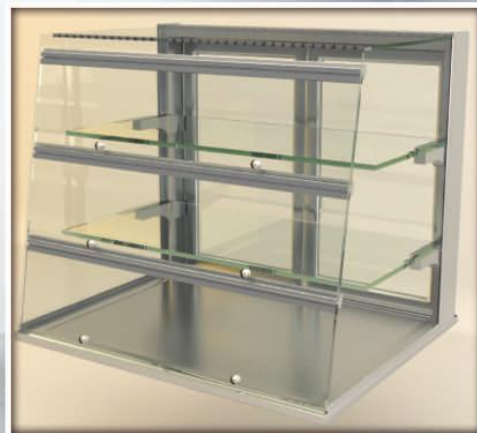

CONSULT FACTORY FOR ADDITIONAL INFORMATION

VIENNA DRY DISPLAY SERIES VIDD-SL

15.

VIENNA DRY DISPLAY SERIES VIDD-SQ

VIDD-SQ SQUARED GLASS



The Vienna Series VIDD-SQ is a non-refrigerated full service display merchandiser designed for countertop application. Unit features squared tilt-open front glass for ease of cleaning and see through hinged rear doors. Can complete a dual temperature line-up next to our VICD-SQ cold display models!

MODEL	L	D	H
VIDD2-20-R-SQ	31 1/2"	27 3/8"	20 7/8"
VIDD3-20-R-SQ	44 1/4"	27 3/8"	20 7/8"
VIDD4-20-R-SQ	57 1/8"	27 3/8"	20 7/8"
VIDD5-20-R-SQ	69 7/8"	27 3/8"	20 7/8"
VIDD2-27-R-SQ	31 1/2"	27 3/8"	27 1/2"
VIDD3-27-R-SQ	44 1/4"	27 3/8"	27 1/2"
VIDD4-27-R-SQ	57 1/8"	27 3/8"	27 1/2"
VIDD5-27-R-SQ	69 7/8"	27 3/8"	27 1/2"
VIDD2-34-R-SQ	31 1/2"	27 3/8"	34 1/4"
VIDD3-34-R-SQ	44 1/4"	27 3/8"	34 1/4"
VIDD4-34-R-SQ	57 1/8"	27 3/8"	34 1/4"
VIDD5-34-R-SQ	69 7/8"	27 3/8"	34 1/4"



ADJUSTABLE SHELVING

SPECIAL FEATURES

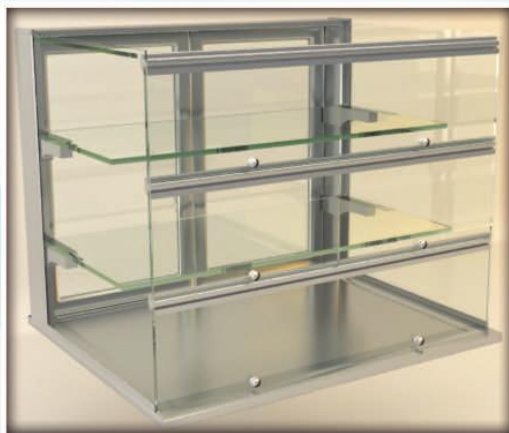

OPTIONAL FLIP-UP ACCESS DOORS AVAILABLE!

16.

CONSULT FACTORY FOR ADDITIONAL INFORMATION

VIENNA SPECIALTY COUNTER TOP DISPLAYS



MODEL	L	D	H
VIDD2-27-R-SL CT FD	31 1/8"	27 3/8"	31 3/4"



VIDD-SL CT FD SLANTED GLASS w/ FLIP-UP DOORS

The Vienna Series VIDD-SL CT FD is a non-refrigerated display merchandiser designed for counter top application, featuring a slanted front profile with "flip-up" compartment doors for self-serve application. Units are standard in stainless steel, with tempered glass shelves, lights and hinged rear see-through access doors.

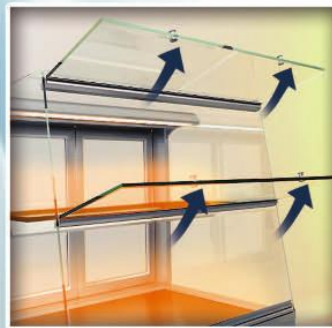
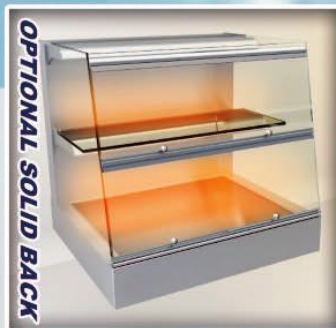

VIHD-SL-CC CT FD SLANTED GLASS w/ FLIP-UP DOORS

The Vienna Series VIHD-SL-CC CT FD is a heated display merchandiser designed for counter top application, featuring a slanted front profile with "flip-up" compartment access doors for self-serve application. Units come standard with black glass shelves, adjustable infrared heating lamps and dial thermostat for desired temperature control. The exterior is tempered glass and includes hinged rear see-through access doors.

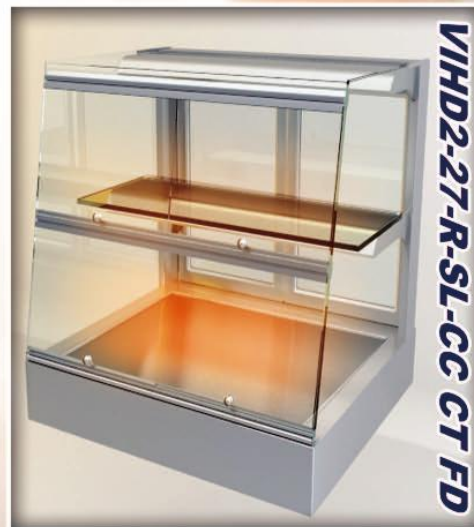

MODEL	L	D	H
VIHD2-27-R-SL-CC CT FD	31 1/8"	27 3/8"	31 3/4"

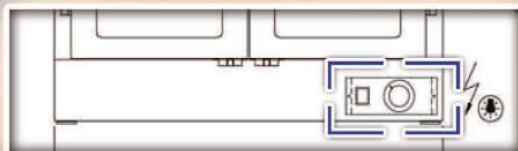

CONTROLS LOCATED ON LOWER REAR RIGHT-HAND CORNER

CONSULT FACTORY FOR ADDITIONAL INFORMATION



VIAS1-34-R-SL-SC SNACKEE

REFRIGERATED OPEN SELF SERVICE DISPLAY

Made of stainless steel with LED lighting under each removable shelf, Grab & go style standard with a pull down night shade.



PULL-DOWN NIGHT CURTAIN (OPTIONAL GRAPHICS)

MODEL	L	D	H
VIAS1-34-R-SL-SC SNACKEE	23 5/8"	27 3/8"	65 15/16"



VIAS1-34-R-SL-SC-FD SNACKEE

REFRIGERATED SELF SERVICE DISPLAY w/ FLIP-UP DOORS

Made of stainless steel with LED lighting under each removable shelf, self serve display with flip-up doors offers a great choice if area may have adverse ambient conditions.



HINGED REAR ACCESS DOOR (SELF CLOSING)

MODEL	L	D	H
VIAS1-34-R-SL-SC-FD SNACKEE	23 5/8"	27 3/8"	65 15/16"



VIHD1-34-R-SL-FD SNACKEE

HEATING DISPLAY w/ FLIP-UP DOORS

Lower black glass plates with upper infrared lamps allow a controlled heating source for holding product for self serve through flip-up doors.



HINGED REAR ACCESS DOOR (SELF CLOSING)

MODEL	L	D	H
VIHD1-34-R-SL-FD SNACKEE	23 5/8"	27 3/8"	45 15/16"

VIDD1-34-R-SL-FD SNACKEE

SELF SERVE AMBIENT DISPLAY w/ FLIP-UP DOORS



**HINGED REAR ACCESS
DOOR (SELF CLOSING)**

A Brightly lit display with removable adjustable shelves with a unique "slow close" flip door allowing for a natural easy closing process.

MODEL	L	D	H
VIDD1-34-R-SL-FD SNACKEE	23 5/8"	27 3/8"	35 7/16"



VIAS1-20-R-SL-RR-LP SNACKEE

PULL-OUT BASE CABINET



**REAR PULL-OUT
STORAGE ACCESS**

Innovation - a full slide out drawer system for this refrigerated air screen allowing quick and easy replenishing from the rear of the unit.

MODEL	L	D	H
VIAS1-20-SL-RR-LP SNACKEE	23 5/8"	36 5/8"	32 1/8"



**INNOVATIVE STYLING
ENHANCING YOUR FOOTPRINT!**

VIENNA "SNACKEE" PRODUCT LINE

VIENNA HOT / COLD COMBO DISPLAY

VSHC4-34-R-SC-SE-ECS



The Vienna Series Hot/Cold Combo offers versatility with 4 functions within a Small footprint. Self serve angled presentation is offered for both heated and refrigerated product with top isolated assisted service. Hot/Cold rear compartments are also available, along with rear slide-out cutting utility boards.

SPECIAL FEATURES

MODEL	L	D	H
VSHC4-34-R-SC-SE-ECS	59 7/16"	43 7/8"	56 1/2"

REAR ACCESS



ABUNDANT STORAGE SPACE!

VIHD2-27-R-SQ-SA-ECS

The Vienna Series Heated display offers humidity within the cabinet by adding a sensor controlled steam generator!

Suitable for holding 2 full size hotel pans!



Hygienic and easy to clean

MODEL	L	D	H
VIHD2-27-R-SQ-SA-ECS	31 1/2"	27 3/8"	63"

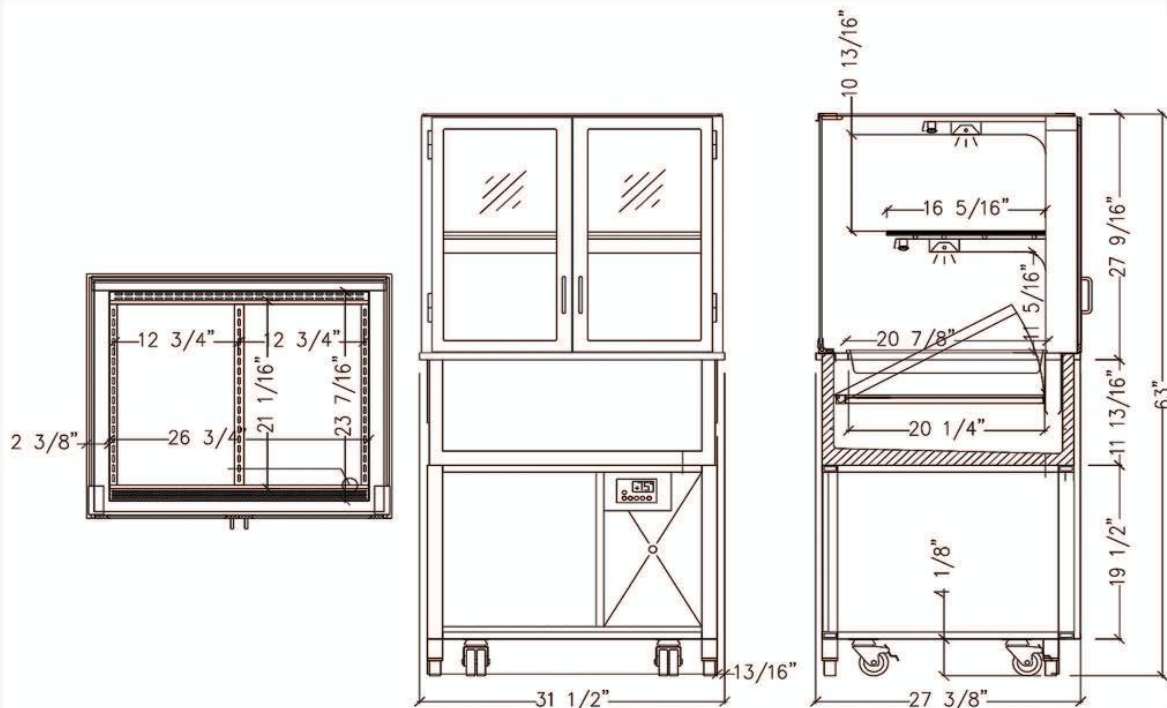

Shown with optional casters / legs in installed positions

CONSULT FACTORY FOR ADDITIONAL INFORMATION 21.

VIENNA HEATED DISPLAY WITH STEAM CONTROL

VIENNA UNIVERSAL HEATED DISPLAY CASE

22

VIAP3-0-R-HC (MOD)



The Vienna Series Universal Heated Display is a multi-functional hot display case with a range of climates controlled by humidity. Unit Features Steam Control, maximum flexibility in a small space, high humidity guaranteed with automatic refill of steamer, rear cutting utility board, and anti-fog glass.

MODEL	L	D	H
VIAP3-0-R-HC (MOD)	44 5/16"	39 3/4"	56 5/16"

SPECIAL FEATURES

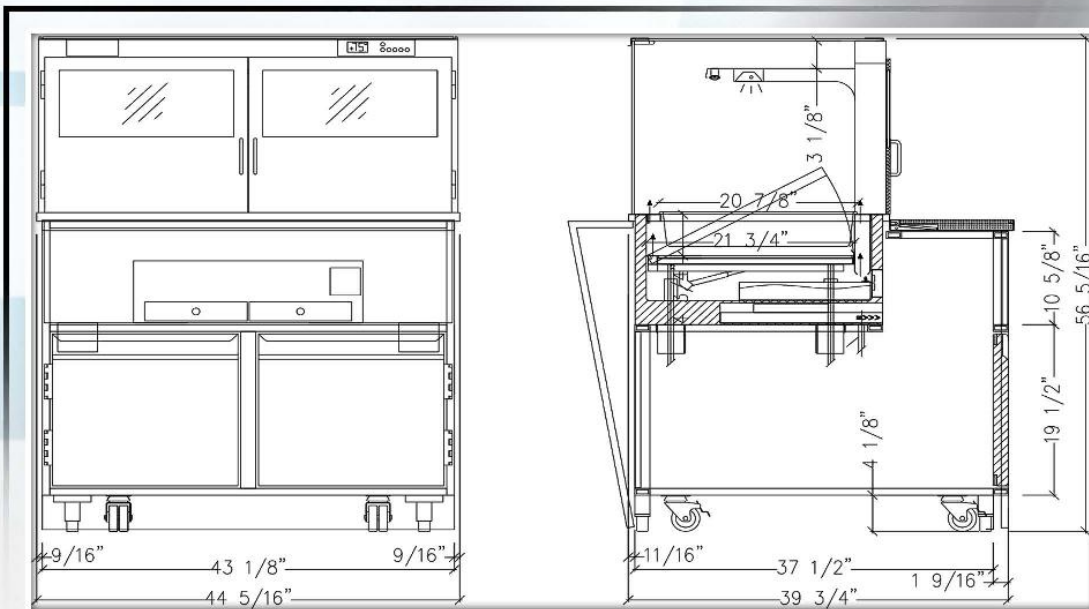

Hygienic and easy to clean

VIHD2-27-R-SQ-CC-SA (MOD)

The Vienna Series Heated Display is a brightly lit display levels for the perfect presentation for hot snacks. The brightly-lit display area provides optimal presentation and quick access to your heated goods. Unit features steam control, an adjustable shelf, Thermal bridges, plate warmers and rear cutting utility board.

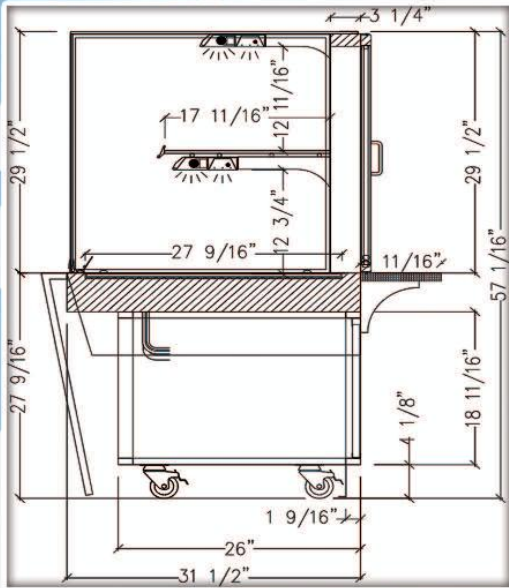

MODEL	L	D	H
VIHD2-27-R-SQ-CC-SA (MOD)	23 5/8"	31 1/2"	57 1/16"

SPECIAL FEATURES

**Seamless line-up
with Cooling Displays!**



CONSULT FACTORY FOR ADDITIONAL INFORMATION 23.

VIENNA HEATED DISPLAY

VIENNA HEATED TOWER DISPLAY



VIHD2-34-R-SQ-WT (MOD)

The Vienna Series Heated Tower is a Multi-functional heating tower with an open front for self service. The brightly-lit display area provides optimal presentation and quick access to your heated goods. Unit features an adjustable night curtain, perforated mirror effect rear wall, and powder coated finish.

MODEL	L	D	H
VIHD2-34-R-SQ-WT (MOD)	22 13/16"	30 5/16"	78 3/4"

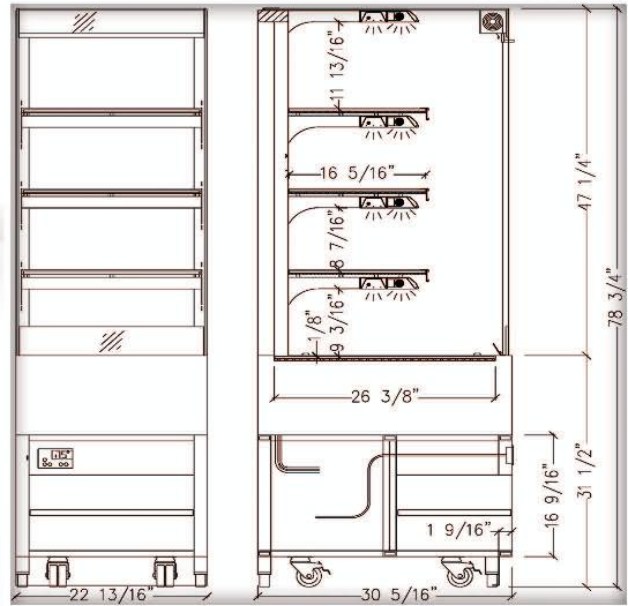

SPECIAL FEATURES



**Seamless line-up
with base & Cooling
Tower Displays!**

VIHD-CC SERIES CLOSED FRONT

The Vienna Series VIHD-CC INS is a slide-in self-service closed heated display merchandiser, featuring infrared heaters and base heaters to provide a uniform cabinet temperature, which is controlled by a dial thermostat for desired temperature. Cabinet temperature is adjustable and ranges from 150 to 185 degrees Fahrenheit. The exterior is insulated glass and includes hinged rear doors. Aside from the curved, slanted, and squared glass profiles, this model is also available in a variety of lengths and heights. Please advise if counter height is 34" or 36". Optional 6" or 8" stainless steel adjustable legs or casters are also available. Designed for packaged foods only.



MODEL	L	D	H
VIHD2-20-R-SQ-CC INS	31 1/2"	27 3/8"	20 7/8"
VIHD3-20-R-SQ-CC INS	44 1/4"	27 3/8"	20 7/8"
VIHD4-20-R-SQ-CC INS	57 1/8"	27 3/8"	20 7/8"
VIHD2-27-R-SQ-CC INS	31 1/2"	27 3/8"	27 1/2"
VIHD3-27-R-SQ-CC INS	44 1/4"	27 3/8"	27 1/2"
VIHD4-27-R-SQ-CC INS	57 1/8"	27 3/8"	27 1/2"
VIHD2-34-R-SQ-CC INS	31 1/2"	27 3/8"	34 1/4"
VIHD3-34-R-SQ-CC INS	44 1/4"	27 3/8"	34 1/4"
VIHD4-34-R-SQ-CC INS	57 1/8"	27 3/8"	34 1/4"



SPECIAL FEATURES

Flex Series Paneling Options



"FP" STYLE "HP" STYLE "HT" STYLE

CONSULT FACTORY FOR ADDITIONAL INFORMATION

VIENNA HEATED DISPLAY SERIES CLOSED

VIENNA HEATED DISPLAY SERIES OPEN

**VIHD-CO SERIES
OPEN FRONT**



The Vienna Series VIHD-CO INS is a slide-in self-service open heated display merchandiser, featuring infrared heaters and base heaters to provide a uniform cabinet temperature, which is controlled by a dial thermostat for desired temperature. Cabinet temperature is adjustable and ranges from 150 to 185 degrees Fahrenheit. The exterior is insulated glass and includes hinged rear doors. Aside from the curved, slanted, and squared glass profiles, this model is also available in a variety of lengths and heights. Please advise if counter height is 34" or 36". Optional 6" or 8" stainless steel adjustable legs or casters are also available. Designed for packaged foods only.



Curved



Slanted

MODEL	L	D	H
VIHD2-20-R-SQ-CO INS	31 1/2"	27 3/8"	20 7/8"
VIHD3-20-R-SQ-CO INS	44 1/4"	27 3/8"	20 7/8"
VIHD4-20-R-SQ-CO INS	57 1/8"	27 3/8"	20 7/8"
VIHD2-27-R-SQ-CO INS	31 1/2"	27 3/8"	27 1/2"
VIHD3-27-R-SQ-CO INS	44 1/4"	27 3/8"	27 1/2"
VIHD4-27-R-SQ-CO INS	57 1/8"	27 3/8"	27 1/2"
VIHD2-34-R-SQ-CO INS	31 1/2"	27 3/8"	34 1/4"
VIHD3-34-R-SQ-CO INS	44 1/4"	27 3/8"	34 1/4"
VIHD4-34-R-SQ-CO INS	57 1/8"	27 3/8"	34 1/4"

SPECIAL FEATURES

Flex Series Paneling Options



"FP" STYLE



"HP" STYLE



"HT" STYLE

Advantage



REAR MOUNTED TEMPERATURE CONTROLS

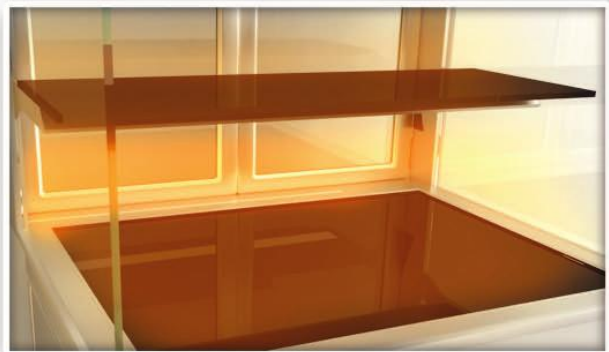

ADJUSTABLE BLACK GLASS SHELVING



HINGED REAR SEE-THROUGH ACCESS DOORS



OPTIONAL REAR CUTTING UTILITY BOARD



INFRARED HEATING UNITS

ADDITIONAL OPTIONS



CASTERS

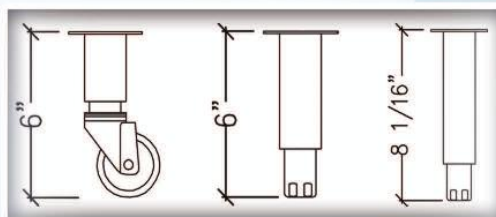

STYLE #1 STYLE #2 STYLE #3



LEGS/BULLET FEET

◀ OPTIONAL ▶



© RPI Industries, Inc. All Rights Reserved.