

A FAMILY COMPANY MANUFACTURING IN THE USA SINCE 1969

Gilastender®

Kitchen Fabrication



Expect more

more flexibility
more features

CHOOSE *your* OPTIONS

- A** Backsplash Styles
- B** Nose Styles
- C** Shelf Styles
- D** Foot Styles

Backsplash Styles

A

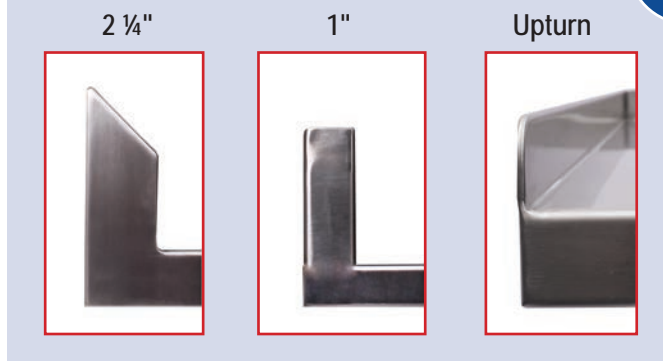

Nose Styles

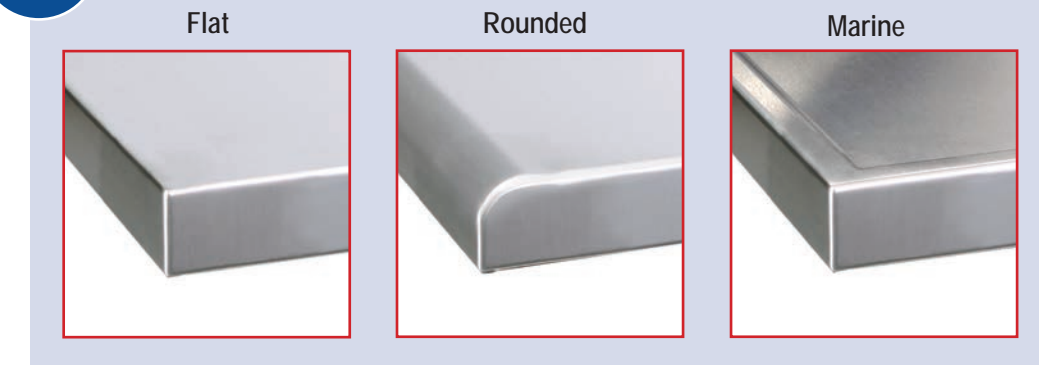

Shelf Styles

C

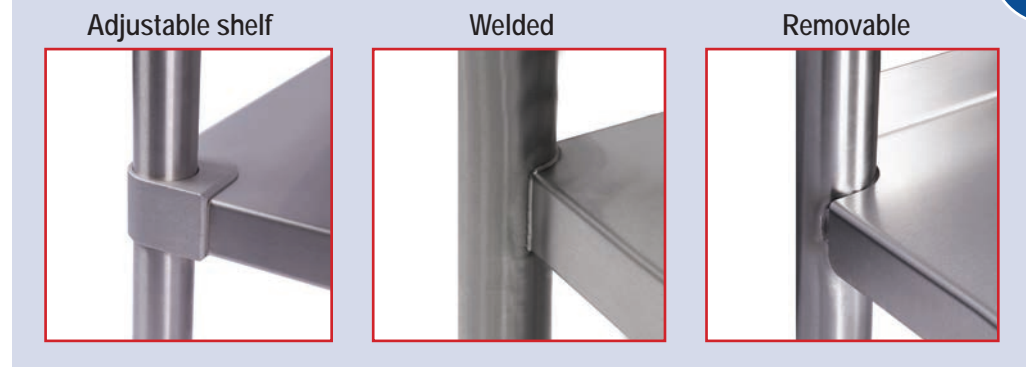

Foot Styles

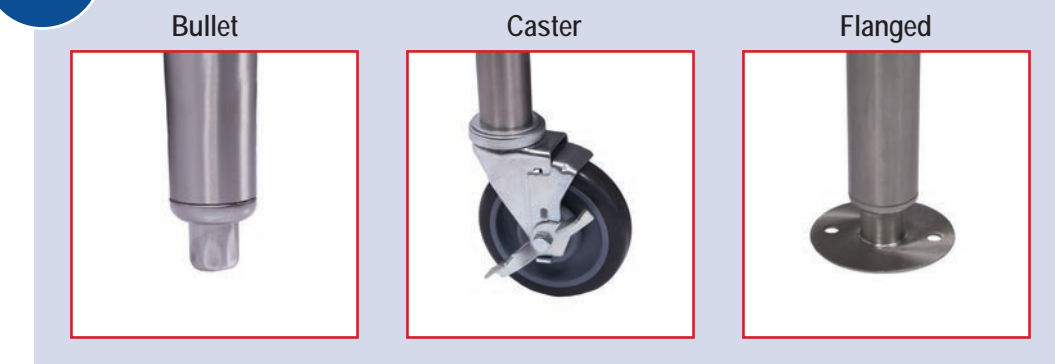

Glastender's highly configurable Work Tables offer flexible solutions to your unique challenges. By selecting from our list of top and base options, you can create a station specific to your operation.

your Features

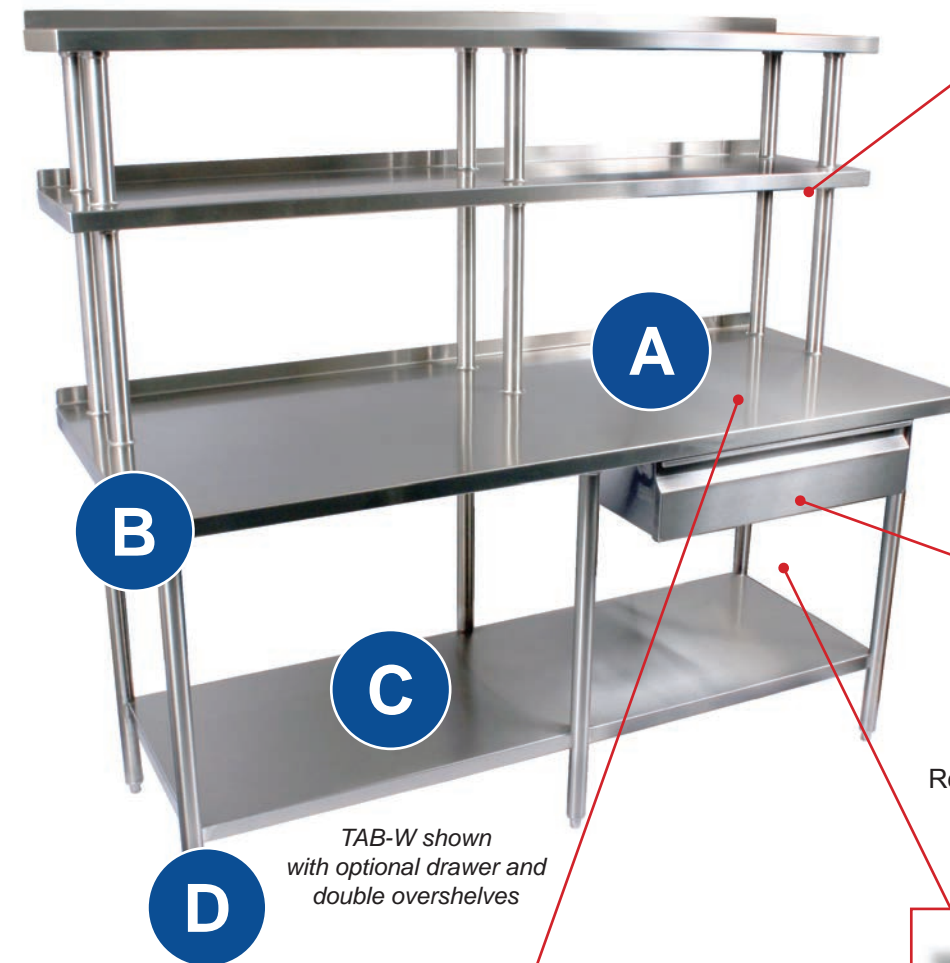

Raised profile for easy cleaning



Removeable pans standard for all drawers

TAB-W shown with optional drawer and double overshelves

Multiple gauge thicknesses and practically endless size options



Recessed style prep sinks with cutting board option



Factory mounted drawer locations where specified, available as single or tiered models

Compartment Sinks & Mop Sinks

Soiled & Clean Dish Tables

Glastender's Compartment Sinks set the standard for durability. Featuring 14 gauge 304 stainless steel tops and in-house fabricated sink bowls, our sinks are built to last. Models can be specified to the one-half inch providing maximum use of your warewashing space.

Glastender's Soiled and Clean Dish Tables offer efficient solutions to your dish room layout. Available in straight, L-Shaped and U-Shaped models, we have configurable options tailored to your flow pattern.

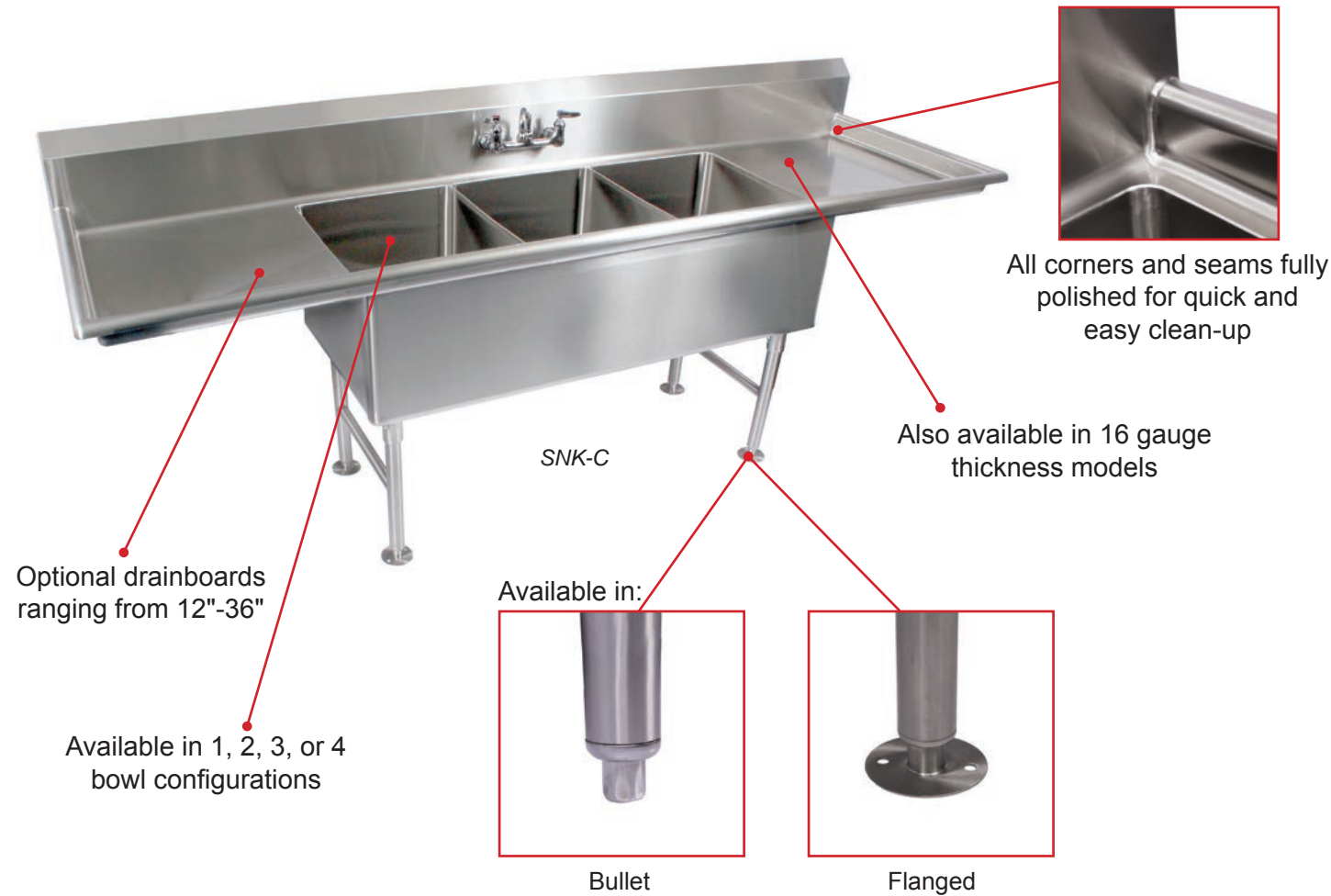

Our Mop Sinks are offered in a variety of sizes and can be specified to the one inch.



Equipment & Mixer Stands

Glastender's Equipment and Mixer Stands are tailor-made to fit your equipment. Depth and length can be specified to the one-half inch and you can select a height for your operation.

Tops available as 14 gauge 304 or 16 gauge 304 stainless steel



Durable double thickness splash



Inverted V or Marine to contain spills

Shelves and Racks

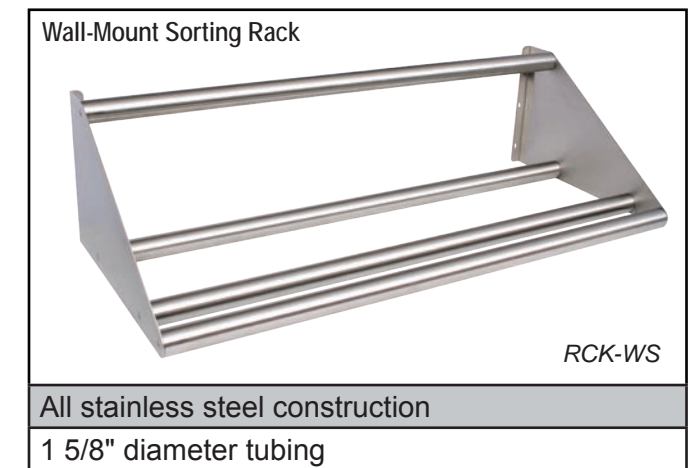
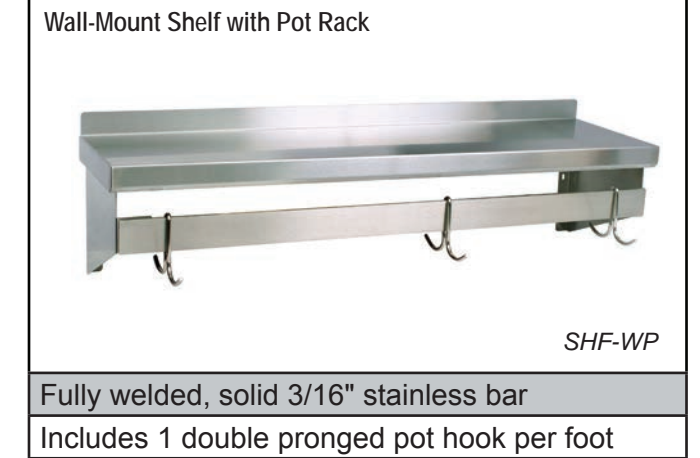

Raised profile for easy cleaning, meets NSF Standard 2



24" units with gusset brackets/
18" units with L-brackets

Work Table Cabinets

Glastender's Work Table Cabinets can be specified to the one-half inch to make the most of your space. Choose from a number of top and base options to personalize your model.

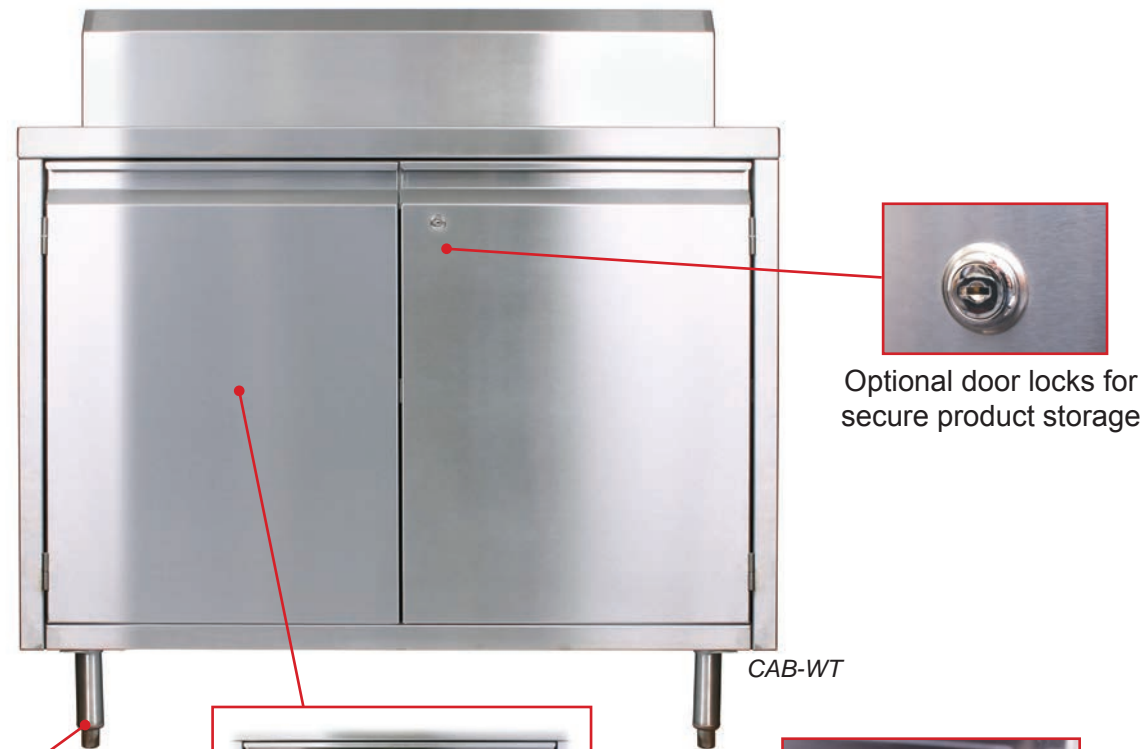

Optional door locks for secure product storage

CAB-WT



Bullet or flanged feet options



Optional louvered doors



All doors feature positive latch catch

Dish Cabinets

Glastender's all stainless steel constructed Dish Cabinets can be mounted on legs or factory mounted to die wall. Offered in both 15" and 18" deep models, you can choose the best option for your space.

Sound deadened 14 gauge stainless steel top



CAB-D

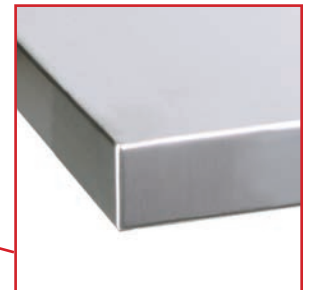

Also available with flat nosing



Dual wall construction makes cleaning a breeze



Die wall mounted

Arrives pre-assembled from the factory in sections up to 9 feet long for easy installation – lowers installation costs

Built-in chaseways allow easy routing of plumbing and electrical lines

Shown with pass-thru shelf options

Shelf options

Adjustable shelf



Fixed shelf



Open storage



Modular Beverage Stations

Top Options



Glastender's highly configurable Modular Beverage Stations are the epitome of flexibility. Our online configurator allows you to specify a station unique to your service. The process is as easy as choosing your top options and selecting any number of module options. Stations ship complete up to 144" long.

visit www.mbs.glastender.com AND configure your own

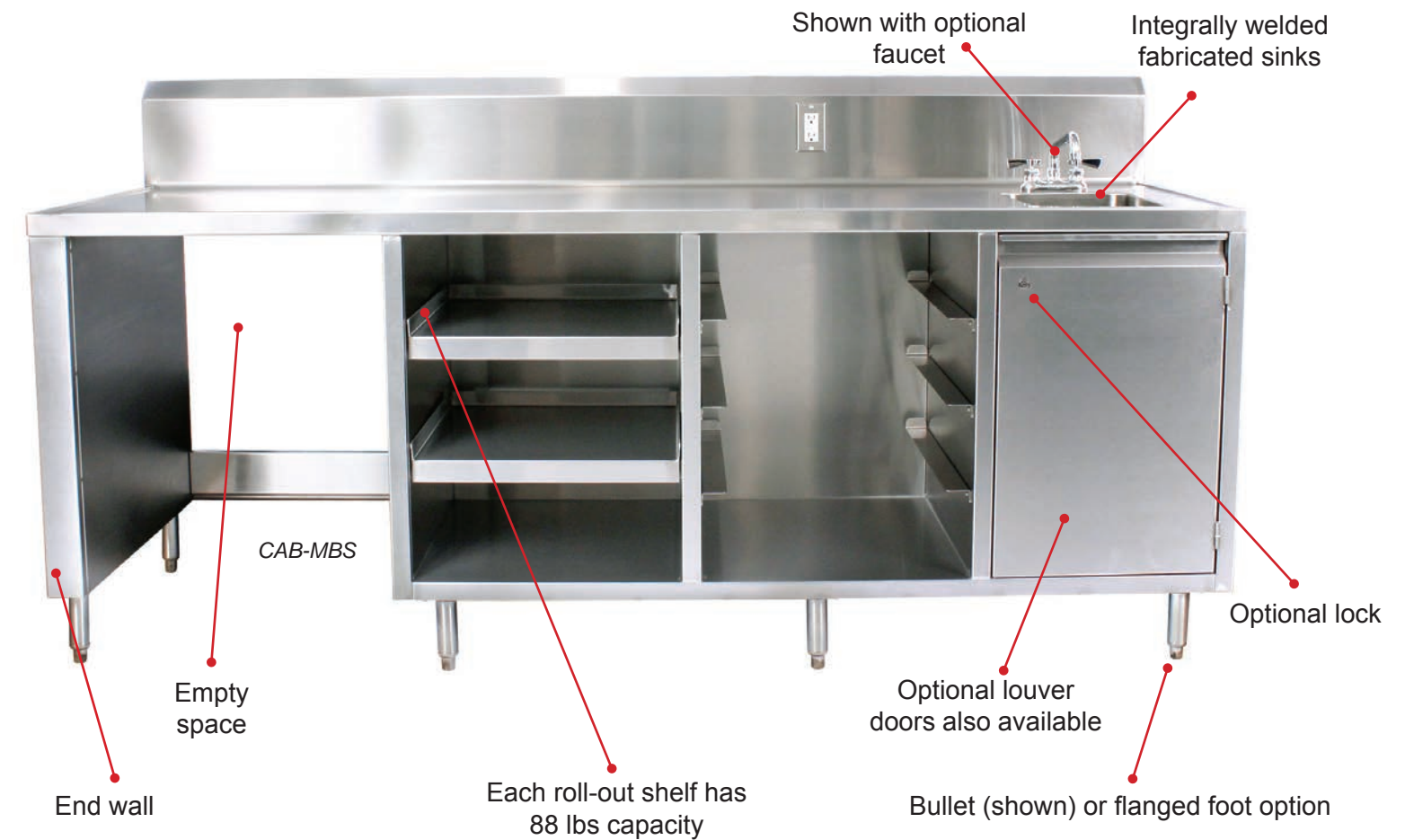

Modular Base Options



Wall Mount Hand Sinks

Glastender's all stainless steel wall-mount hand sinks are manufactured with total welded construction to meet all NSF standards. Optional heavy-duty faucets are NSF/ANSI 61 listed drinking water components and NSF/ANSI 372 listed for low lead compliance.



WH-14



All sink bowls are seamless welded to the work surface for easy cleaning.

Base models WH-14, WH-12, and WH-14-S (shown left), are available with a skirt to cover the bowl. (shown below)



WHS-14



WH-12



At 12" wide, models WH-12 and WHS-12 include a special backsplash faucet mounting bracket for easy removal and inspection of faucet after installation.



WHS-12



WH-14-S



While all wall-mount hand sinks are available with the optional side splash accessory, models WH-14-S and WHS-14-S feature integral side splashes, radius work surface corners for easy cleaning, and a 1" deep recessed work surface to contain splashes.



WHS-14-S

Model WH-14-ESD includes C-fold paper towel and built-in soap dispenser.



WH-14-ESD

Model WH-14-ESD includes a 1" deep recessed work surface to contain splashes



Model WDH-14 includes C-fold paper towel and built-in soap dispenser.



WDH-14



Glastender's unique hand sink design has all welded construction and uses C-channel stiffeners in the side and backsplash to provide unparalleled strength to prevent sagging.

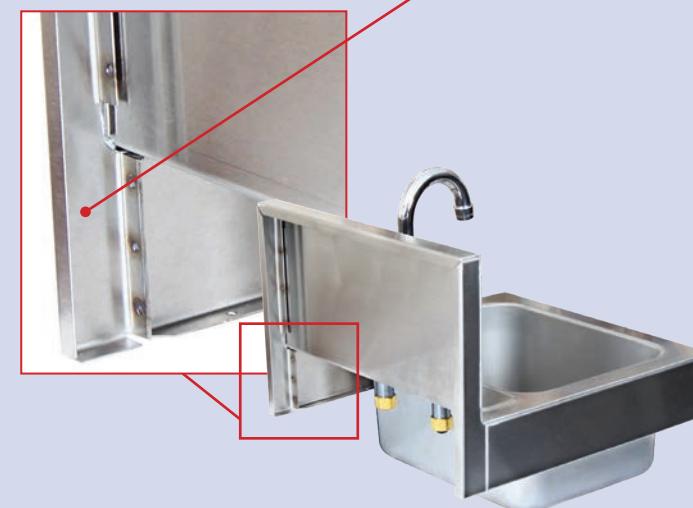

Industry standard wall-mount hand sinks are manufactured with rear corner notch fillers that create a weak spot that is prone to bending.



Drop-In Hand Sinks, Ice Bins, and Combination Units

Glastender manufactures ten different drop-in models. From sinks and ice bins to water stations that include seamless welded drainboards, we can handle your service station needs.

Seamless welded sink bowl satisfies stringent health code requirements.

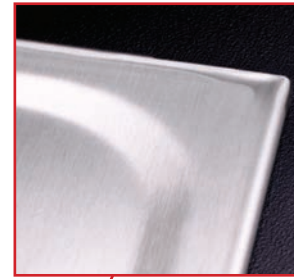
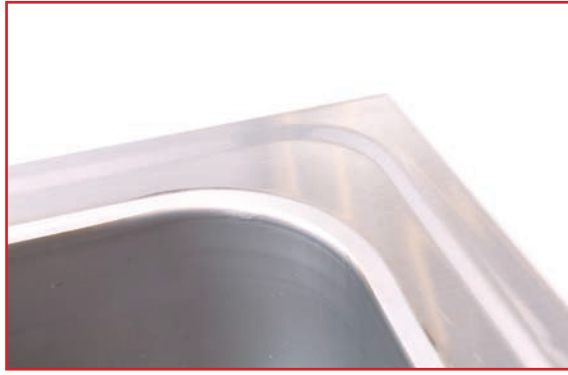

Unique hemmed edge for added strength and visual appeal.

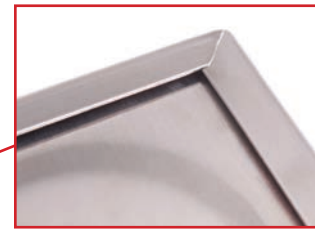

Mounting stud assembly clips into hemmed edge preventing damage to work surface when installing.

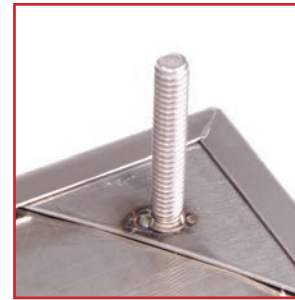

DI-HS12-LF

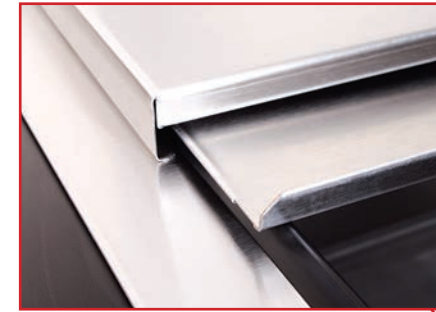

Standard two-piece sliding cover meets health code requirements.

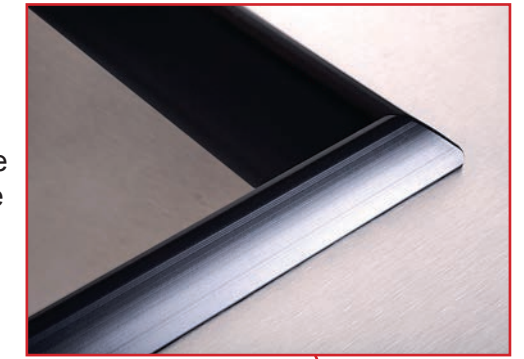

PVC Plastic breaker stop around ice bin liner acts as a thermal barrier to minimize condensation and maximize ice life.



Drop-in ice bins feature special angle brackets, U-channels, and mounting bolts for an easy, secure installation.

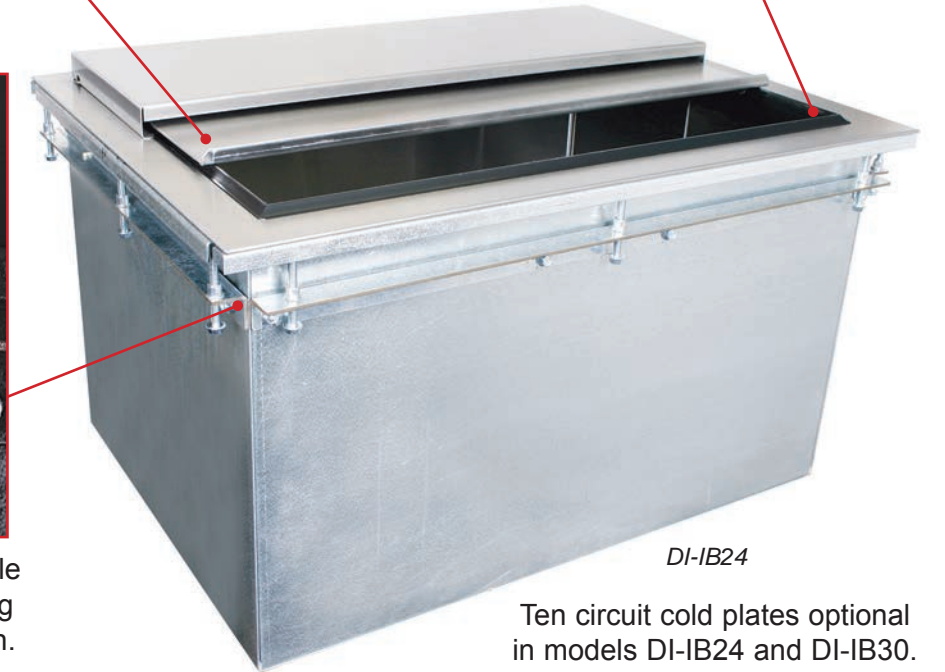

DI-IB24

Ten circuit cold plates optional in models DI-IB24 and DI-IB30. (add suffix '-CP10' to model number)

Four sizes of drop-in ice bins available

Ten different models available to handle various applications



DI-HS14



DI-IB24



DI-IS24



DI-IW24

Mobile Ice Baths

Glastender's mobile ice baths are great for iced product storage and merchandising. The units are 24" front-to-back and available in 36" or 48" lengths.

PVC plastic breaker strip around ice bin liner acts as a thermal barrier to minimize condensation and maximize ice life.

Stainless steel interior with 1/4" radius corners for easy cleaning.

Foamed-in-place insulated cabinet.



Includes a flexible drain line with on/off valve for draining when most convenient.

Built-in storage area below ice bath.

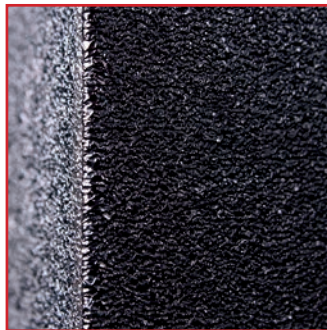

Durable black vinyl-clad exterior.

Stainless steel floor is easily removable and has 1/4" radius corners for easy cleaning.

Includes four heavy duty rubberized 3" casters. (two locking)



MIB-36-H

The standard models have a 30" work height. The '-H' models feature a taller cabinet base and a 36" work height. The '-ED' models feature an extra deep bath and a 36" work height.



MIB-36



MIB-36-H



MIB-36-ED

Mobile Ice Bin

The easy to clean all stainless steel interior and exterior construction of Glastender's mobile ice bin is designed to accommodate demanding work environments. The 18" by 30" unit includes four 4" heavy duty rubberized casters (two locking) and has a 30" high work surface.



IBM-18X30

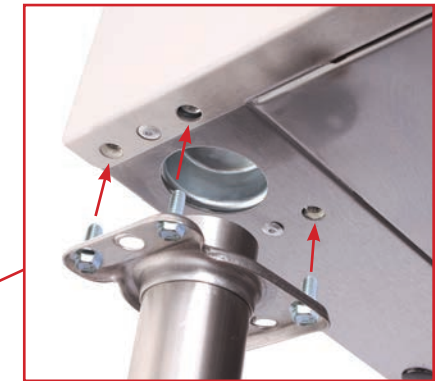

Recessed leg tube sockets and bottom floor for extra stability and additional storage.



Includes on/off drain valve for draining when most convenient.



Includes four heavy duty rubberized 4" casters (two locking).



1/4" radius interior corners for easy cleaning.



Also available with enclosed base

Ice Pan Holder

Glastender's ice pan holder has no drain and is small enough for easy transport, so it can be conveniently located wherever you have a need for chilled product storage.

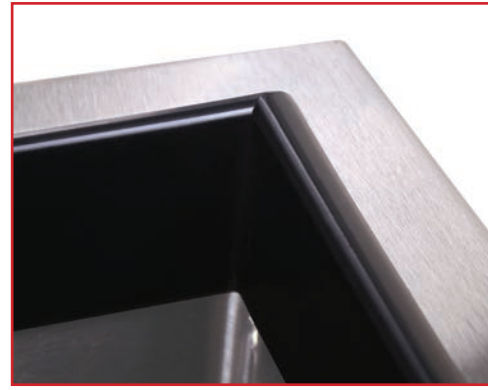

PVC plastic breaker strip around ice bin liner acts as a thermal barrier to minimize condensation and maximize ice life.



The IB-14X22 is 14" by 22" with an 8-3/4" deep liner designed to accommodate one steam table pan (not included).

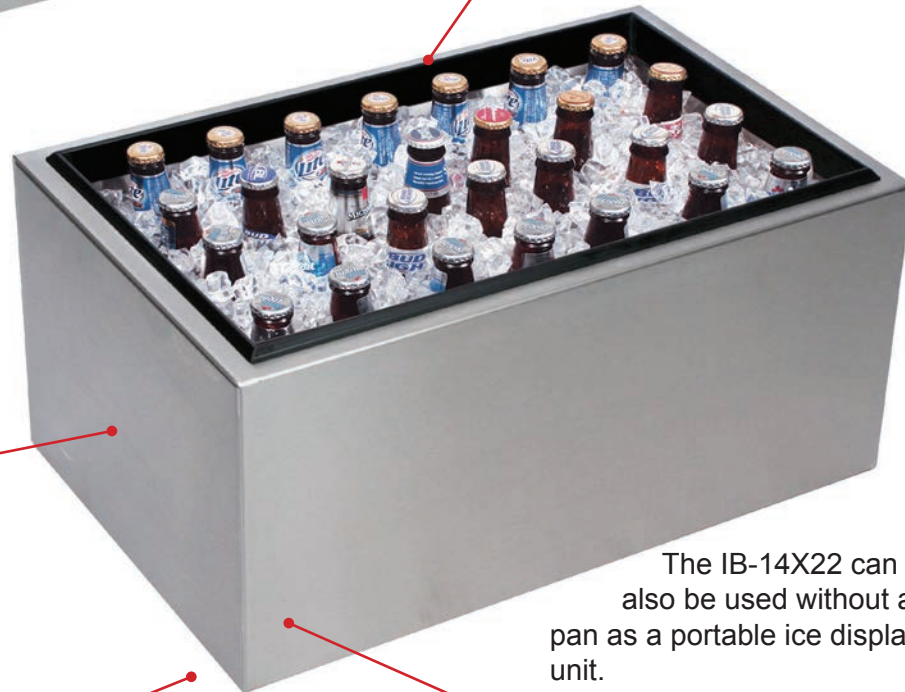

Foamed-in-place insulation for longer ice life.

The IB-14X22 can also be used without a pan as a portable ice display unit.



Smooth PVC trim on the bottom surface helps to protect counter top surfaces.

All stainless steel interior and exterior construction.

1/4" radius interior corners for easy cleaning.



Wall Cabinets

Glastender's all 18 gauge stainless steel wall cabinets provide durable easy to clean storage for your dry goods. Available with an open front or with hinged doors in 24" to 96" lengths. The door models up to 48" have two doors and the 60" to 96" models have four doors.



Units with doors include door locks standard for secure product storage.



Lift-off door hinges for easy removal and cleaning.



Door models have durable stainless steel hinges and handles.



Door models include positive latch catch to prevent accidental opening.

Sloping top to create sanitary surface.

Includes wall mounting bracket.

Includes stationary intermediate shelf.



Closed wall construction for an easy to clean interior.



WCO24

Also available...

Kitchen Refrigeration

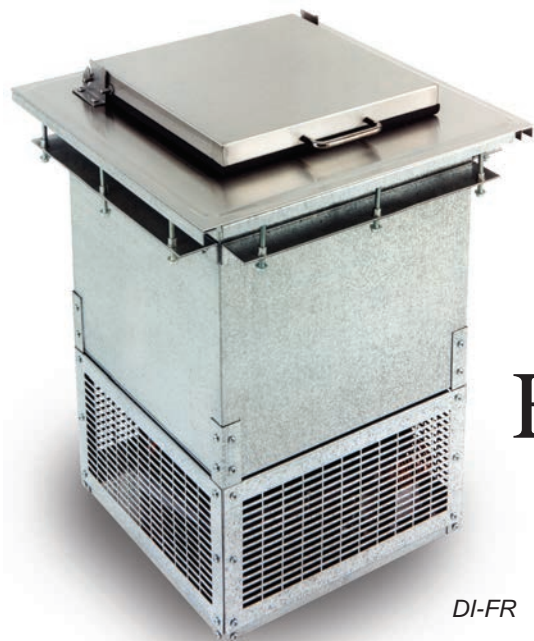

DI-FR

Expect more
more flexibility
more features



LC



C1SU24

Glastender®

Glastender manufactures a variety of specialty kitchen refrigeration products to provide solutions for niche applications.

The flexibility you want. The features you need.

Glastender. Expect more.